







Circuit-breaker, 4 p, 200A

Part no. **LZMB2-4-A200-1**
 Article no. **116432**

Similar to illustration

Delivery programme

Product range				Circuit-breaker
Protective function				System and cable protection
Standard/Approval				IEC
Installation type				Fixed
Release system				Thermomagnetic release
Construction size				LZM2
Description				Set value in neutral conductor is synchronous with set value I_r of main pole.
Number of poles				4 pole
Standard equipment				Screw connection
Switching capacity				
400/415 V 50/60 Hz	I_{cu}	kA		25
Rated current = rated uninterrupted current				
Rated current = rated uninterrupted current	$I_n = I_u$	A		200
Neutral conductor	% of phase conductor	CSA		100
Setting range				
Overload trip				
	I_r	A		160 - 200
Main pole				
	I_r	A		160 - 200
Short-circuit releases				
				
Non-delayed				
	$I_i = I_n \times \dots$			6 - 10

Technical data

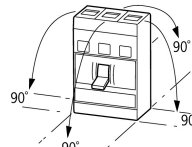
General				
Standards				IEC/EN 60947, VDE 0660
Protection against direct contact				Finger and back-of-hand proof to VDE 0106 part 100
Climatic proofing				Damp heat, constant, to IEC 60068-2-78 Damp heat, cyclic, to IEC 60068-2-30
Mechanical shock resistance (10 ms half-sinusoidal shock) according to IEC 60068-2-27		g		20 (half-sinusoidal shock 20 ms)
Safe isolation to EN 61140				
Between auxiliary contacts and main contacts		V AC		500
between the auxiliary contacts		V AC		300
Weight		kg		3.5
Mounting position				Vertical and 90° in all directions
				 <p>With XFI earth-fault release: - NZM1, N1, NZM2, N2: vertical and 90° in all directions with plug-in unit - NZM1, N1, NZM2, N2: vertical, 90° right/left with withdrawable unit:</p>

- NZM3, N3: vertical, 90° left
- NZM4, N4: vertical with remote operator:
- NZM2, N(S)2, NZM3, N(S)3, NZM4, N(S)4: vertical and 90° in all directions

Direction of incoming supply		as required
Degree of protection		
Device		In the area of the HMI devices: IP20 (basic protection type)
Enclosures		with insulating surround: IP40 with door coupling rotary handle: IP66
Terminations		Tunnel terminal: IP10 Phase isolator and band terminal: IP00

Circuit-breakers

Rated current = rated uninterrupted current	$I_n = I_u$	A	200
Rated surge voltage invariability	U_{imp}		
Main contacts		V	8000
Auxiliary contacts		V	6000
Rated operational voltage	U_e	V AC	440
Overvoltage category/pollution degree			III/3
Rated insulation voltage	U_i	V	690
Use in unearthed supply systems		V	 440

Switching capacity

Rated short-circuit making capacity	I_{cm}		
240 V 50/60 Hz	I_{cm}	kA	63
400/415 V 50/60 Hz	I_{cm}	kA	53
440 V 50/60 Hz	I_{cm}	kA	53
Rated short-circuit breaking capacity I_{cn}	I_{cn}		
I_{cu} to IEC/EN 60947 test cycle O-t-CO	I_{cu}	kA	
240 V 50/60 Hz	I_{cu}	kA	30
400/415 V 50/60 Hz	I_{cu}	kA	25
440 V 50/60 Hz	I_{cu}	kA	25
525 V 50/60 Hz	I_{cu}	kA	15
I_{cs} to IEC/EN 60947 test cycle O-t-CO-t-CO	I_{cs}	kA	
230 V 50/60 Hz	I_{cs}	kA	30
400/415 V 50/60 Hz	I_{cs}	kA	25
440 V 50/60 Hz	I_{cs}	kA	18.5
			Maximum back-up fuse, if the expected short-circuit currents at the installation location exceed the switching capacity of the circuit-breaker.
Utilization category to IEC/EN 60947-2			A
Rated making and breaking capacity			
Rated operational current	I_e	A	
AC-1			
380 V 400 V	I_e	A	300
415 V	I_e	A	300
AC--3			
380 V 400 V	I_e	A	200
415 V	I_e	A	200
660 V 690 V	I_e	A	200
Lifespan, mechanical	Operations		20000
Lifespan, electrical			
AC-1			
400 V 50/60 Hz	Operations		10000
415 V 50/60 Hz	Operations		10000
AC-2, AC-3			
415 V 50/60 Hz	Operations		6500
Max. operating frequency		Ops/h	120

Current heat losses per pole at I_{cr} are based on the maximum rated operational current of the frame size.	W	19
		For current heat loss per pole the specification refers to the maximum rated operational current of the frame size.
Total downtime in a short-circuit	ms	< 10

Terminal capacity

Standard equipment			Screw connection																																			
Overview			<p>Basic equipment</p> <table border="1"> <tr> <td>Box terminal</td> <td>●</td> <td>-</td> <td>-</td> <td>-</td> </tr> <tr> <td>Screw connection</td> <td>-</td> <td>●</td> <td>●</td> <td>●</td> </tr> </table> <p>accessory consideration</p> <table border="1"> <tr> <td>Box terminals</td> <td>-</td> <td>●</td> <td>●</td> <td>-</td> </tr> <tr> <td>Screw connection</td> <td>●</td> <td>-</td> <td>-</td> <td>●</td> </tr> <tr> <td>Tunnel terminal connection on rear Strip terminal</td> <td>●</td> <td>●</td> <td>●</td> <td>●</td> </tr> <tr> <td></td> <td>●</td> <td>●</td> <td>●</td> <td>●</td> </tr> <tr> <td></td> <td>-</td> <td>-</td> <td>-</td> <td>●</td> </tr> </table>	Box terminal	●	-	-	-	Screw connection	-	●	●	●	Box terminals	-	●	●	-	Screw connection	●	-	-	●	Tunnel terminal connection on rear Strip terminal	●	●	●	●		●	●	●	●		-	-	-	●
Box terminal	●	-	-	-																																		
Screw connection	-	●	●	●																																		
Box terminals	-	●	●	-																																		
Screw connection	●	-	-	●																																		
Tunnel terminal connection on rear Strip terminal	●	●	●	●																																		
	●	●	●	●																																		
	-	-	-	●																																		
Round copper conductor																																						
Box terminal																																						
Solid		mm ²	1 x (4 - 16) 2 x (4 - 16)																																			
Stranded		mm ²	1 x (25 - 185) 2 x (25 - 70)																																			
Tunnel terminal																																						
Solid		mm ²	1 x 16																																			
Stranded		mm ²																																				
Stranded		mm ²	1 x (25 - 185)																																			
Bolt terminal and rear-side connection																																						
Direct on the switch																																						
Solid		mm ²	1 x (4 - 16) 2 x (4 - 16)																																			
Stranded		mm ²	1 x (25 - 185) 2 x (25 - 70)																																			
Al conductors, Cu cable																																						
Solid		mm ²	1 x 16																																			
Stranded		mm ²																																				
Stranded		mm ²	1 x (25 - 185)																																			
Bolt terminal and rear-side connection																																						
Flat copper strip, with holes	min.	mm	2 x 16 x 0.8																																			
Flat copper strip, with holes	max.	mm	10 x 16 x 0.8																																			
Cu strip (number of segments x width x segment thickness)																																						
Box terminal																																						
	min.	mm	2 x 9 x 0.8																																			
	max.	mm	10 x 16 x 0.8																																			
Bolt terminal and rear-side connection																																						
Flat copper strip, with holes	min.	mm	2 x 16 x 0.8																																			
Flat copper strip, with holes	max.	mm	10 x 16 x 0.8																																			
Copper busbar (width x thickness)		mm																																				
Bolt terminal and rear-side connection																																						
Screw connection			M8																																			
Direct on the switch																																						
	min.	mm	16 x 5																																			
	max.	mm	20 x 5																																			
Control cables																																						

	mm ²	1 x (0.75 - 2.5) 2 x (0.75 - 1.5)
--	-----------------	--------------------------------------

Design verification as per IEC/EN 61439

Technical data for design verification			
Rated operational current for specified heat dissipation	I _n	A	200
Equipment heat dissipation, current-dependent	P _{vid}	W	48
IEC/EN 61439 design verification			
10.2 Strength of materials and parts			
10.2.2 Corrosion resistance			Meets the product standard's requirements.
10.2.3.1 Verification of thermal stability of enclosures			Meets the product standard's requirements.
10.2.3.2 Verification of resistance of insulating materials to normal heat			Meets the product standard's requirements.
10.2.3.3 Verification of resistance of insulating materials to abnormal heat and fire due to internal electric effects			Meets the product standard's requirements.
10.2.4 Resistance to ultra-violet (UV) radiation			Meets the product standard's requirements.
10.2.5 Lifting			Does not apply, since the entire switchgear needs to be evaluated.
10.2.6 Mechanical impact			Does not apply, since the entire switchgear needs to be evaluated.
10.2.7 Inscriptions			Meets the product standard's requirements.
10.3 Degree of protection of ASSEMBLIES			Does not apply, since the entire switchgear needs to be evaluated.
10.4 Clearances and creepage distances			Meets the product standard's requirements.
10.5 Protection against electric shock			Does not apply, since the entire switchgear needs to be evaluated.
10.6 Incorporation of switching devices and components			Does not apply, since the entire switchgear needs to be evaluated.
10.7 Internal electrical circuits and connections			Is the panel builder's responsibility.
10.8 Connections for external conductors			Is the panel builder's responsibility.
10.9 Insulation properties			
10.9.2 Power-frequency electric strength			Is the panel builder's responsibility.
10.9.3 Impulse withstand voltage			Is the panel builder's responsibility.
10.9.4 Testing of enclosures made of insulating material			Is the panel builder's responsibility.
10.10 Temperature rise			The panel builder is responsible for the temperature rise calculation. Eaton will provide heat dissipation data for the devices.
10.11 Short-circuit rating			Is the panel builder's responsibility. The specifications for the switchgear must be observed.
10.12 Electromagnetic compatibility			Is the panel builder's responsibility. The specifications for the switchgear must be observed.
10.13 Mechanical function			The device meets the requirements, provided the information in the instruction leaflet (IL) is observed.

Technical data ETIM 6.0

Low-voltage industrial components (EG000017) / Power circuit-breaker for trafo/generator/installation prot. (EC000228)			
Electric engineering, automation, process control engineering / Low-voltage switch technology / Circuit breaker (LV < 1 kV) / Circuit breaker for power transformer, generator and system protection (ecl@ss8.1-27-37-04-09 [AJZ716010])			
Rated permanent current I _u		A	200
Rated voltage		V	690 - 690
Rated short-circuit breaking capacity I _{cu} at 400 V, 50 Hz		kA	25
Overload release current setting		A	160 - 200
Adjustment range short-term delayed short-circuit release		A	0 - 0
Adjustment range undelayed short-circuit release		A	1200 - 2000
Integrated earth fault protection			No
Type of electrical connection of main circuit			Screw connection
Device construction			Built-in device fixed built-in technique
Suitable for DIN rail (top hat rail) mounting			No
DIN rail (top hat rail) mounting optional			Yes
Number of auxiliary contacts as normally closed contact			0
Number of auxiliary contacts as normally open contact			0
Number of auxiliary contacts as change-over contact			0
Switched-off indicator available			No
With under voltage release			No
Number of poles			4

Position of connection for main current circuit		Front side
Type of control element		Rocker lever
Complete device with protection unit		Yes
Motor drive integrated		No
Motor drive optional		Yes
Degree of protection (IP)		IP20

Characteristics

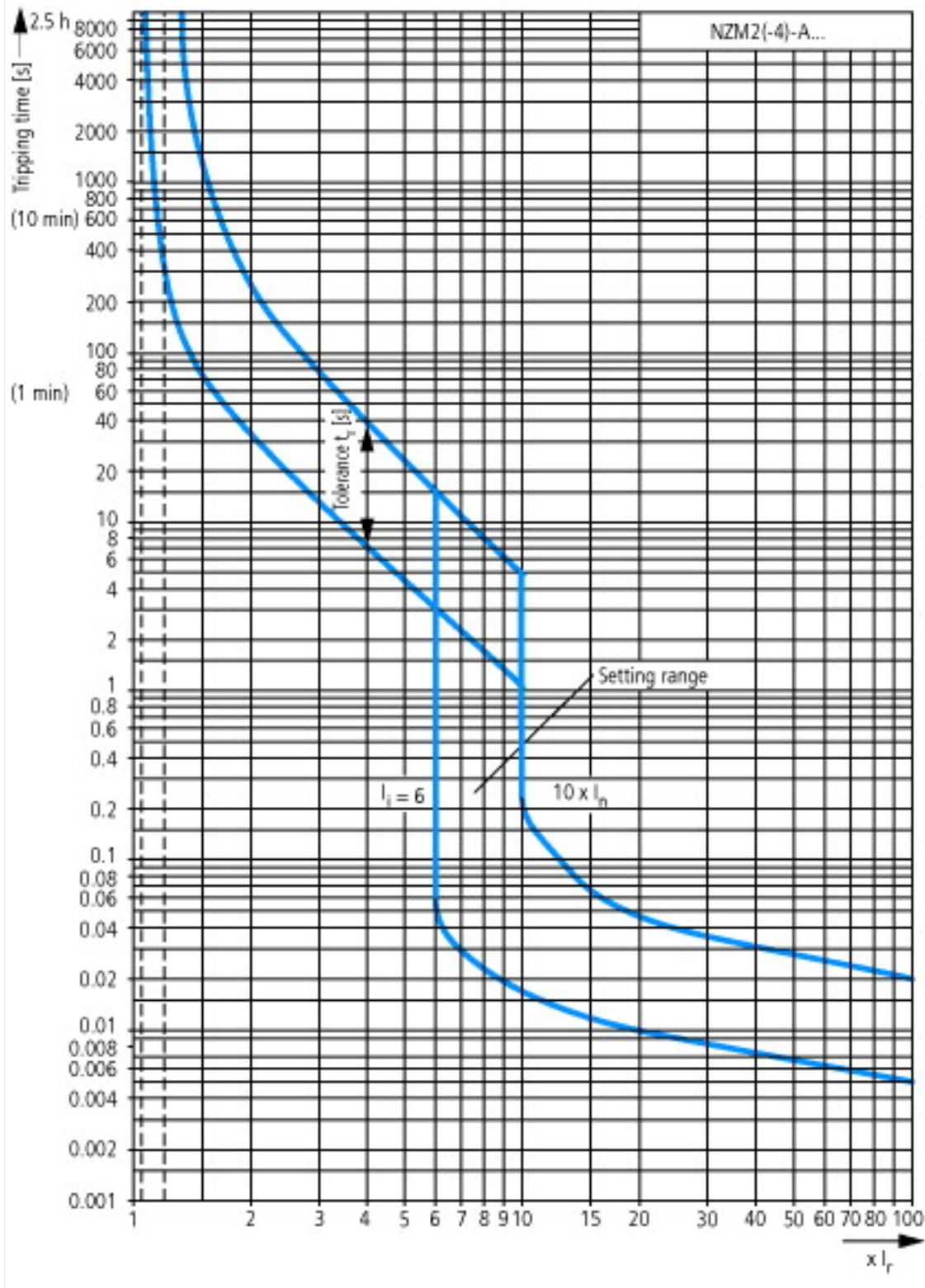

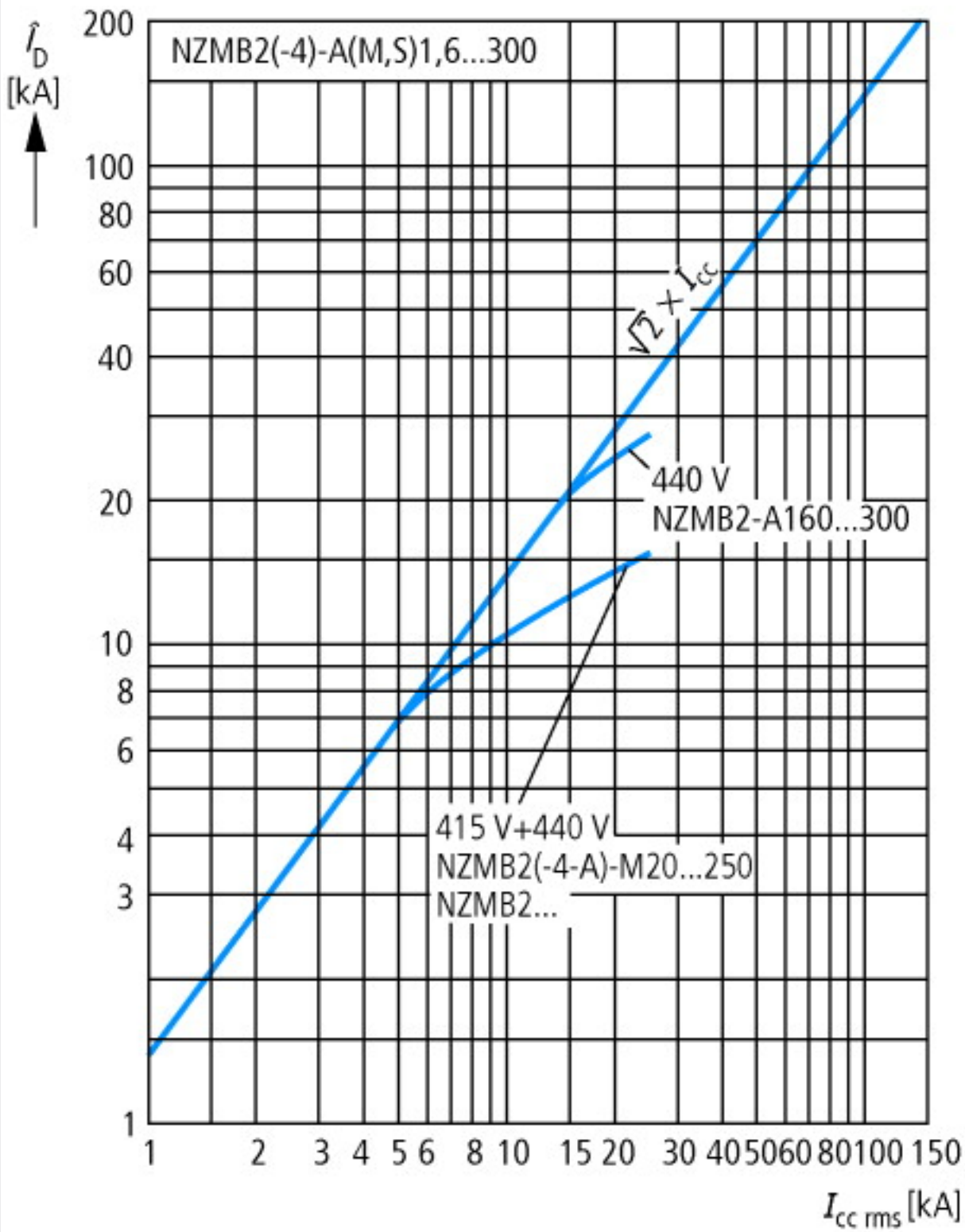

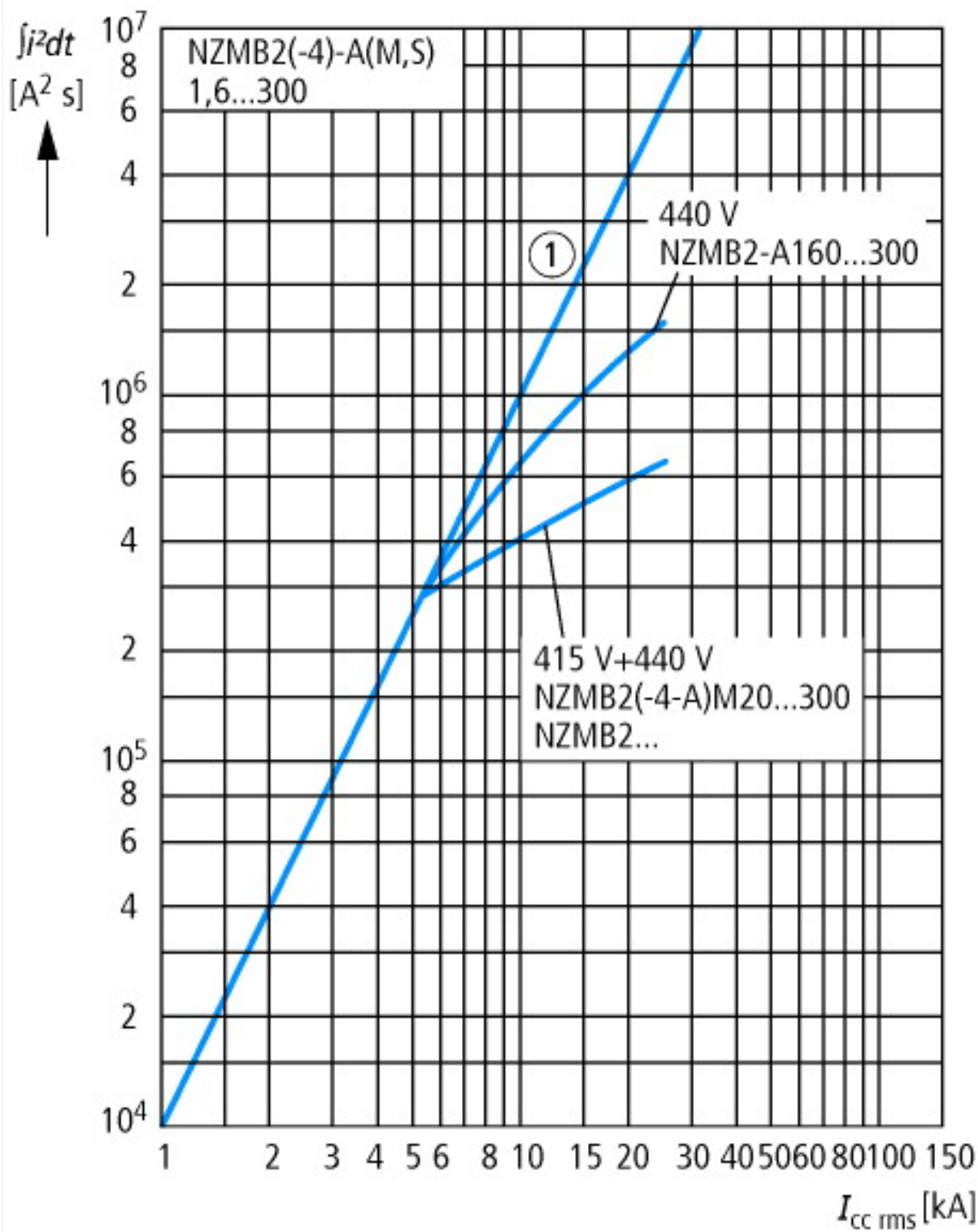

Dimensions

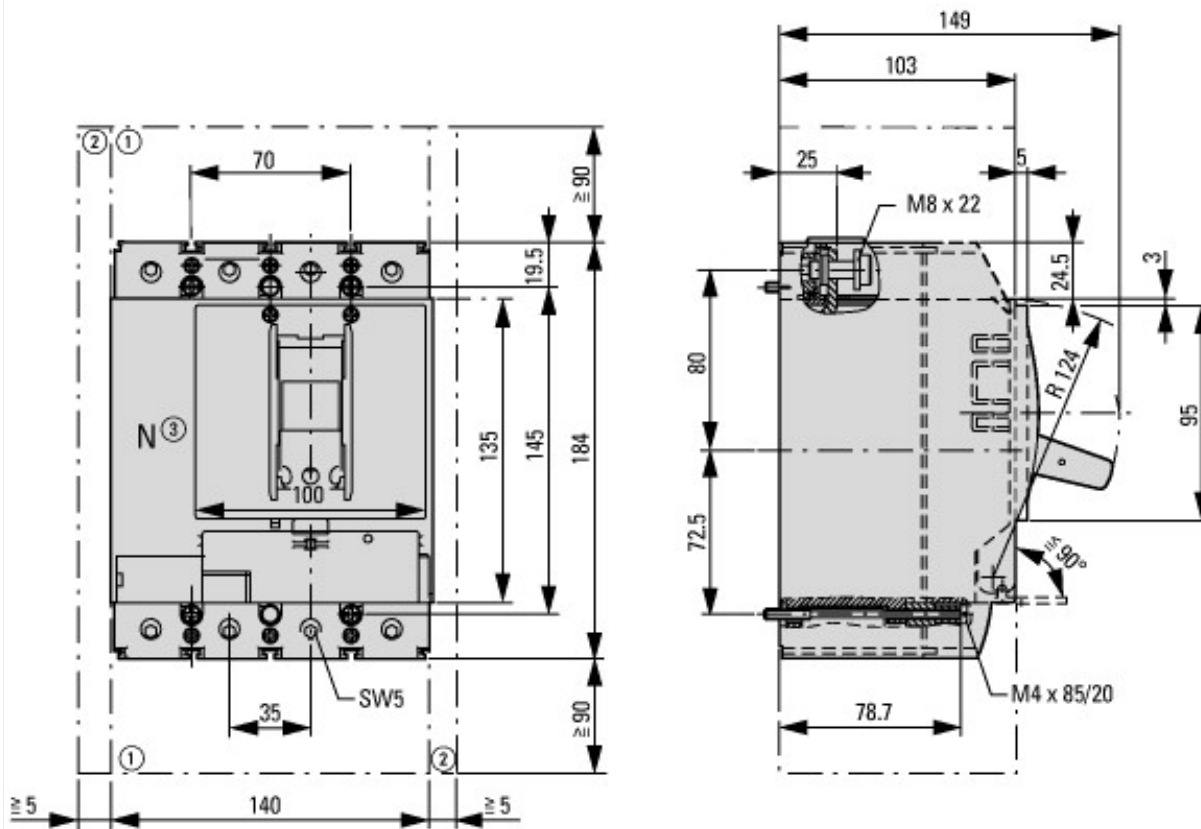

- ① Blow out area, minimum clearance to other parts
- ② Minimum clearance to adjacent parts



Additional product information (links)

IL01206012Z circuit-breaker LZMB2, switch-disconnector LN2

IL01206012Z circuit-breaker LZMB2, switch-disconnector LN2

ftp://ftp.moeller.net/DOCUMENTATION/AWA_INSTRUCTIONS/IL01206012Z2013_08.pdf